

# 2-Flange Tunnel Liner Plate Design Guide

---

## 2nd Edition

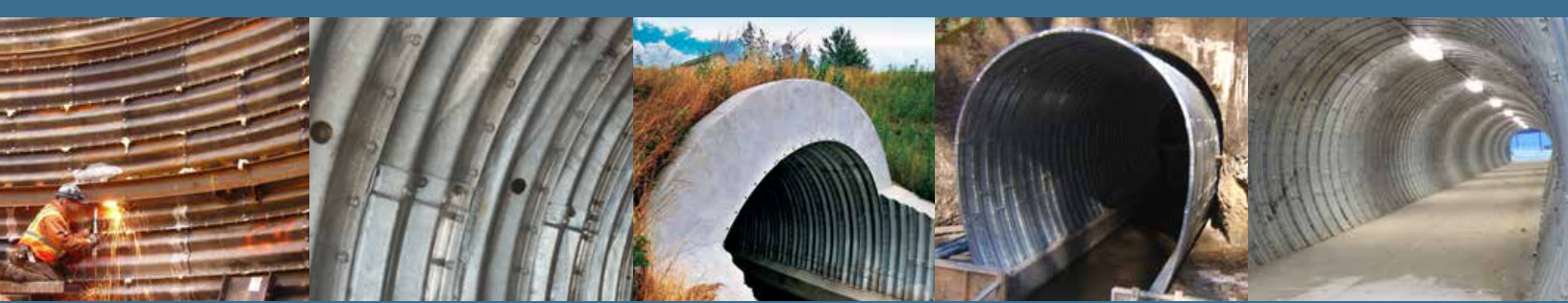

**Steel Tunnel Liner Plate**

**Aluminum Tunnel Liner Plate**



# Contech 2-Flange Tunnel Liner Plate

Contech® 2-Flange Tunnel Liner Plate provides optimum stability and protection when constructing new tunnels, relining structures under highways and railroads, and vertical shafts. It offers the highest continuous ring stiffness and high compression joint strength. 2-Flange Tunnel Liner Plate has effective stiffness that is more than twice that of the same gage (thickness) of 4-Flange Liner Plate.

## Applications

- Tunnel Lining
- Relining (rehabilitation of failing structures)
- Both Vertical and Horizontal Shafts

## Features & Benefits

- Minimizes installation expense
- Optimizes stability in both horizontal and vertical applications
- Unsurpassed in strength and safety

## Special shapes of Contech Liner Plate

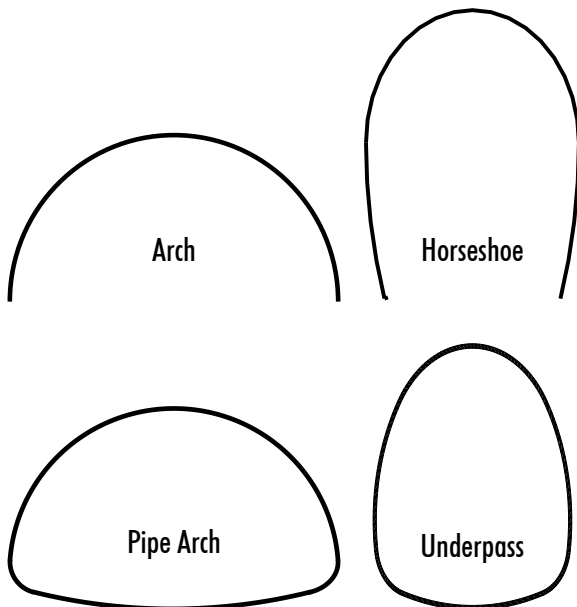

# Contech 2-Flange Tunnel Liner Plate vs. 4-Flange Liner Plate

**2-Flange** Tunnel Liner Plate from Contech provides corrugations extending through the lapped longitudinal joint. When assembled, this liner functions as a corrugated pipe with continuous circumferential corrugations. The result is more effective corrugation performance for the highest stiffness and strength in the industry. It has the strength to handle the loads encountered during construction, providing a safer working environment.

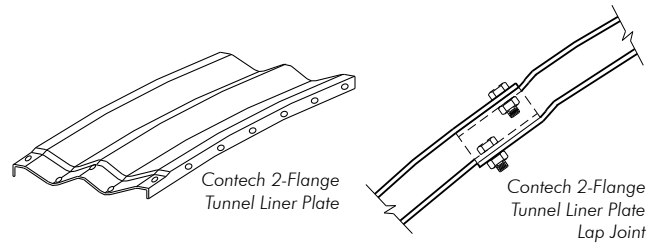

Deep, full length corrugations and lapped joints for more effective stiffness and ring compression.

**4-Flange** Liner Plate feature shallow, partial corrugations that do not extend fully to the joint. When assembled, ring stiffness is limited by both the joint strength and lack of a continuous corrugation. The result is less stiffness and a hinge action joint.

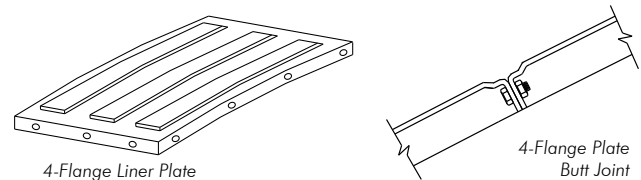

Shallow corrugations and hinged joint.

## Key Performance Differences

- Bending strength of the deep, fully corrugated 2-Flange Tunnel Liner Plate is much greater than 4-Flange Liner Plate.
- AASHTO Design Specifications for Tunnel Liner Plate, Section 15, states that effective stiffness of 2-Flange Tunnel Liner Plate is 2.22 x stiffer than equal thickness 4-Flange Liner Plate ( $111/50 = 2.22$  – see Table 1A).
- The overlapped joint of 2-Flange Tunnel Liner Plate provides greater effective stiffness, when assembled, than 4-Flange Liner Plate.
- AASHTO Design Specifications for Tunnel Liner Plate, Section 15, states that the seam strength of 2-Flange Tunnel Liner Plate is up to 30% greater than 4-Flange Liner Plate.

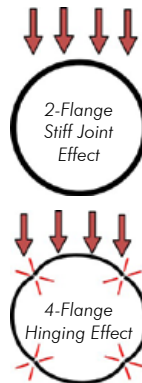

Contech 2-Flange Tunnel Liner provides stiff joints with no hinging effect

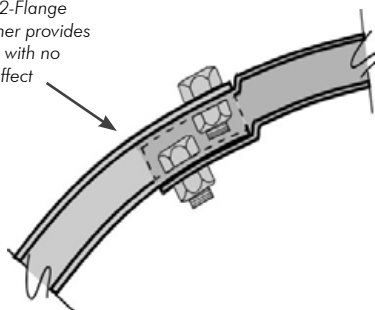

## What is the practical meaning of all this?

During tunnel construction, slough-ins and other concentrated loads are unpredictable and can be catastrophic without adequate protection. A sufficiently stiff tunnel liner functions as a safety zone for workers and equipment. The required amount of liner stiffness depends upon soils, tunnel size and construction methods.

If minimum effective stiffness required for a project is related in terms of thickness of Contech 2-Flange Tunnel Liner Plate, an equally stiff 4-Flange Liner Plate must have more than twice the moment of inertia. Minimum installation stiffness often governs the plate thickness, and in the case of Contech 2-Flange Tunnel Liner Plate, provides the most economical Liner Plate option.

Table 1A - Equal Stiffness of 2-Flange vs. 4-Flange

2-Flange Tunnel Liner Plate Thickness	Equivalent 4-Flange Liner Plate Thickness
0.075	0.179
0.105	0.239
0.135	0.375

Table 1B - Minimum Installation Stiffness

2-Flange Tunnel Liner Plate	Equivalent 4-Flange Liner Plate
50	111

NOTE: Per AASHTO Design Specifications for Tunnel Liner Plates, Section 15.

# AASHTO Design\*

## Loading Considerations

The load carrying capacity of a non-rigid tunnel lining such as a steel Liner Plate results from its ability to deflect under load so that side restraint developed by the lateral resistance of the soil constrains further deflection. Deflection tends to equalize radial pressures resulting in ring compression.

The load carried by the tunnel liner plate is dependent on the type of soil. In granular soil, with little or no cohesion, the load is a function of the internal friction angle ( $\phi$ ,  $\emptyset$ ) of the soil and the diameter of the tunnel. In cohesive soils, such as clays and silty clays, the load carried by the tunnel liner is dependent on the shearing strength of the soil above the tunnel.

Before design, appropriate soil test should be performed at each installation site.

Chart I – Coefficient  $C_d$  for Tunnels in Soil ( $\phi$  = Internal Friction Angle)

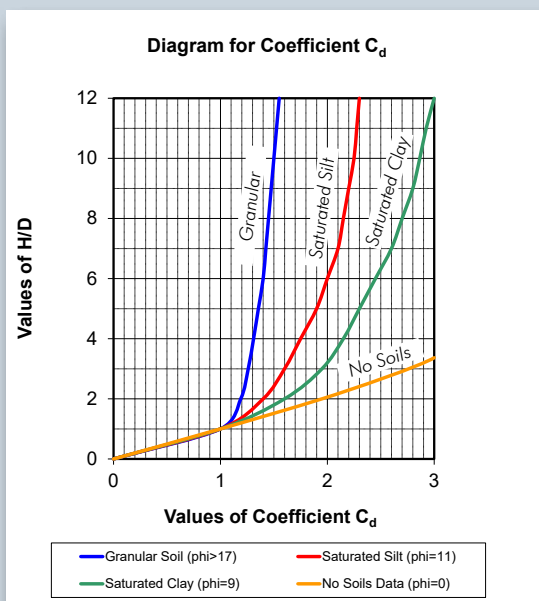

\*Per AASHTO Standard Design Specifications for Tunnel Liner Plates, Section 15 and AASHTO LRFD Section 12.13.

Highway <sup>1</sup>		Railroad <sup>2</sup>	
Height of Cover (ft.)	H 20 Load (lb. per ft. <sup>2</sup> )	Height of Cover (ft.)	E 80 Load (lb. per ft. <sup>2</sup> )
4	400	4	3,000
5	250	5	2,400
6	200	8	1,600
7	175	10	1,100
8	100	12	800
9	90	15	600
10	75	20	300
> 10	0	30	100

1. Based on AASHTO Design Specifications
2. AREMA Manual for Railway Engineering, Section 1.4

## Loads per AASHTO Section 15.2.1

External load on any circular tunnel liner may be predicted by various methods, including actual tests. In cases where more precise methods of analysis are not employed, the external load,  $P$ , can be predicted by the following:

- If the grouting pressure is greater than the computed external load, the external load  $P$  on the tunnel liner shall be the grouting pressure.
- In general the external load can be computed by the formula:

$$P = P_L + P_d$$

Where:

$P$  = The external load on the tunnel liner.

$P_L$  = The vertical load at the level of the top of the tunnel liner due to live loads (see Table 2 for approximate values).

$P_d$  = The vertical load at the level of the top of the tunnel liner due to dead load.

Values of  $P_d$  may be calculated using Marston's formula for load or any other suitable method.

$$P_d = C_d \times W \times D$$

Where:

$C_d$  = Coefficient for tunnel liner (see Chart I).

$W$  = Total (moist) unit weight of soil.

$D$  = Neutral axis diameter of span.\*

$H$  = Height of soil over the top of the tunnel.

In addition to the loads described above, grouting pressures should be considered on the tunnel liner.

\*  $D$  (diameter) as referenced in this brochure always represents a neutral axis dimension.

In the absence of adequate borings and soil tests, the full overburden height should be the basis for  $P_d$  in the Tunnel Liner Plate design: ( $P_d = H \times W$ ).



# AASHTO Design

## Design Criteria

The following criteria must be considered in the design of Liner Plates:

- Joint strength
- Minimum stiffness for installation
- Critical buckling of the Liner Plate wall
- Deflection or flattening of tunnel section

The design criteria described is per AASHTO design. Other design methodologies and publications may allow different factors of safety and minimum stiffness values.

*Note: Sizes shown in this brochure are to the neutral axis, not the inside diameter.*

## Joint Strength

Seam strength for Liner Plates should be sufficient to withstand the thrust developed from the total load supported by the Liner Plate. This thrust, T, in pounds per linear foot is:

$$T = P \times D/2$$

Where: P = Load as defined on Page 4.  
D = Neutral axis diameter or span.

Thrust, T, multiplied by the factor of safety (FS) as required should not exceed the ultimate seam strength shown in Table 4 on Page 9.

## Minimum Stiffness for Installation

The Liner Plate ring should have enough rigidity to resist the unbalanced loadings of normal construction, including grouting pressure, local slough-ins, and miscellaneous concentrated loads.

The minimum stiffness required for these loads can be expressed for convenience by the following formula.

It must be recognized, however, that the limiting values given here are only recommended minimums. Actual job conditions may require higher values (greater effective stiffness). Final determination on this factor of safety should be based on intimate knowledge of the project, soil conditions, and practical experience.

The minimum stiffness for installation is determined by the formula:

$$\text{Minimum stiffness} = EI/D^2$$

Where: D = Neutral axis diameter or span.  
E = Modulus of elasticity, psi.  
I = Moment of inertia, (in<sup>4</sup>/in).

For 2-Flange:  $EI/D^2 = 50$  minimum

For 4-Flange:  $EI/D^2 = 111$  minimum

*Note: An appropriate factor of safety is recommended. The effect of such an increase in factor of safety on the installed cost of a tunnel is typically very small.*



# AASHTO Design

## Critical Buckling

Wall buckling stresses are determined from the following formulas:

Determine  $D_c$  the critical pipe diameter or span:

$$D_c = \frac{r}{k} \sqrt{\frac{24E}{f_u}}$$

For diameters less than  $D_c$ :

$$f_y = f_u - \left[ \frac{f_u^2}{48E} \times \left( \frac{D}{r} \right)^2 \right] \text{ (psi)}$$

For diameters greater than  $D_c$  then:

$$f_y = \left( \frac{12E}{\left( \frac{D}{r} \right)^2} \right) \text{ (psi)}$$

Variables as defined by AASHTO Section 15.

- Where:  $f_u$  = Minimum specified tensile strength, psi.  
 $f_y$  = Buckling stress, psi,  $F_{cr}$  cannot exceed  $F_y$ .  
 $k$  = Soil stiffness factor, will vary from 0.22 for soils with  $\phi > 15^\circ$  to 0.44 for soils  $\phi < 15^\circ$ .  
 $D$  = Pipe diameter or max span, inches.  
 $r$  = Radius of gyration of section, inches.  
 $E$  = Modulus of elasticity, psi.  
 $\phi$  = Internal friction angle of soil.

Design for buckling is accomplished by limiting the ring compression thrust,  $T$ , to the buckling stress multiplied by the effective cross-sectional area of the Liner Plate,  $A$ , divided by the factor of safety:

- Where:  $T$  = Thrust per linear foot.  
 $A$  = Effective cross-sectional area of Liner Plate,  $\text{in}^2/\text{ft}$ .  
 $FS$  = Factor of safety (2) for buckling.



## Deflection and Grouting

Deflection of a tunnel depends significantly on the amount of over-excavation of the bore and is also affected by delay in grouting or inadequate grouting. The magnitude of deflection is not primarily a function of soil modulus or the Liner Plate properties, so it cannot be computed with usual deflection formulas. Where the tunnel clearances are important, the designer should oversize the structure to provide for normal deflection.



## Minimum Cover

For tunneling, a minimum cover of four feet, depending upon soil material, should be considered to prevent loss of overhead material. However, actual minimum cover required for a specific tunnel application is highly dependent on various factors, including site conditions, tunnel diameter, soil characteristics, and live load conditions, and must be determined by a qualified engineer or tunneling contractor.

# Design Example

2-Flange Tunnel Liner Plate is designed to provide effective continuous ring stiffness and high compression joint strength. Continuous ring stiffness in 2-Flange Tunnel Liner Plate prevents hinge action at longitudinal joints. This bending strength is useful to maintain structure shape during installation and grouting.

After installation and back grouting, the ring must possess sufficient compressive wall strength and buckling resistance to carry the final loading on the ring. These loads approach a pattern of symmetry and thus place the 2-Flange Tunnel Liner Plate ring primarily in compression.

## Design Example (Steel)

### Assumed

- H = 20' E80 Live Load
- D = Dia. = 144" (see Marston's theory for diameter, B)
- W = 120 lb./CF (saturated clay)
- K = 0.44
- E =  $29 \times 10^6$
- $f_u = 42,000$  psi\*
- $f_y = 28,000$  psi\*

\*These values are prior to cold working and are conservative for 2-Flange Tunnel Liner Plate.

Stiffness is often the control for plate thickness, so the calculation for it will be done first.

## I. Minimum Stiffness for Installation

### Construction Load Design

The design engineer should use an appropriate factor of safety for stiffness. Final determination of this factor of safety should be based on intimate knowledge of the project soil conditions and the contractor's experience. In this example a factor of safety of 1.5 was selected.

$$\text{Stiffness} = EI/D^2$$

To provide FS = 1.5, set minimum stiffness equal to  $1.5 \times 50 = 75$ . Find requirement of moment of inertia (I).

$$I = \frac{D^2 \times (\text{Minimum Stiffness})}{E} = \frac{(144)^2 (75)}{29 \times 10^6} = 0.0536 \text{ in}^4/\text{in}$$

Select 0.1345" 2-Flange Tunnel Liner Plate with  $I = 0.064 \text{ in}^4/\text{in}$  (from Table 3 on Page 8).

$$\frac{H}{D} = \frac{20}{12} = 1.67$$

## II. Final Load Design

### 1. Find Load

Now use Chart I to find that  $C_d = 1.36$

$$P_d = C_d \times W \times D$$

$$P_d = 1.36 \times 120 \times 12 = 1,596 \text{ lb/ft}^2$$

From Table 2,  $P_L = 300 \text{ lb/ft}^2$

$$P = P_d + P_L = 1,958 + 300 = 2,258 \text{ lb/ft}^2$$

### 2. Joint Strength

Actual thrust

$$T = P \times D/2$$

$$T = 2,258 \times 12/2$$

$$T = 13,548 \text{ lb./LF}$$

Minimum factor of safety required (AASHTO) = 3

From Table 4, 0.1345 2-Flange Tunnel Liner Plate (ultimate seam strength is 47,000 lb./LF)

Check factor of safety  $47,000/13,548 = 3.47$

$3.47 > 3.0$ , therefore the factor of safety for 2-Flange Tunnel Liner Plate is sufficient for the joint strength.



### 3. Critical Buckling

From Table 3, radius of gyration “r” for 0.1345 plate = 0.606

$$\frac{r}{k} \sqrt{\frac{24E}{f_u}} = \frac{0.606}{0.44} \sqrt{\frac{(24)(29,000,000)}{42,000}} = 177$$

Tunnel diameter (84”) is less than 177, therefore use

$$f_y = f_u - \left[ \frac{f_u^2}{48E} \times \left( \frac{D_c}{r} \right)^2 \right]$$

$$= 42,000 - \left[ \frac{(42,000)^2}{48 \times (29 \times 10)^6} \times \left( \frac{0.44 \times 144}{0.606} \right)^2 \right] = 28,147$$

This exceeds the yield point of the corrugated plate (28,000 psi), therefore use  $f_y = 28,000$  psi. Check factor of safety for 0.1345 2-Flange Tunnel Liner Plate where  $A = 0.174$  in<sup>2</sup>/ft (Table 3).

The resulting factor of safety is 4.32, which is greater than the required FS of 2.

TABLE 3 - Properties and Dimensions of 2-Flange Tunnel Liner Plate

Nominal Thickness (Inches) t	Area (In <sup>2</sup> per Inch) A	Section Modulus (In <sup>3</sup> per Inch) S	Moment of Inertia (In <sup>4</sup> per Inch) I	Radius of Gyration (Inches) r	X* (Inches)	Approx. Plate Weights including Bolts (Pounds)		
<b>STEEL</b>						12 Pi. Plate	14 Pi. Plate	16 Pi. Plate
14 GA** / 0.0747	0.096	0.0323	0.034	0.595	0.757	25	28	31
12 GA / 0.1046	0.135	0.0457	0.049	0.602	0.779	33	37	42
10 GA / 0.1345	0.174	0.0590	0.064	0.606	0.799	41	47	52
8 GA / 0.1644	0.213	0.0726	0.079	0.609	0.819	49	56	63
7 GA / 0.1793	0.233	0.0798	0.087	0.611	0.831	53	61	68
5 GA / 0.2092	0.272	0.0928	0.103	0.615	0.848	61	70	79
3 GA / 0.2391	0.312	0.1065	0.118	0.615	0.869	70	80	90
<b>ALUMINUM</b>						12 Pi. Plate	14 Pi. Plate	16 Pi. Plate
0.125	0.160	0.0540	0.0583	0.603	0.782	15	17	19
0.150	0.191	0.0649	0.0711	0.610	0.799	17	19	22
0.175	0.227	0.0756	0.0842	0.610	0.827	19	22	25
0.200	0.260	0.0864	0.0972	0.611	0.842	21	24	27
0.225	0.292	0.0972	0.1108	0.615	0.851	24	27	30
0.250	0.325	0.1080	0.1230	0.615	0.874	26	30	33

\* X = Distance from outer face to neutral axis, in inches. See page 9, Section B-B.

\*\* 14 GA is available upon special request.

Refer to AASHTO Standard Specifications for Highway Bridges Section 15, and AASHTO LRFD Bridge Design Specifications Section 12.

Refer to Section 12.13 for t, A, I, and r; and Table 12.13.3.1-1 for nominal thicknesses (uncoated). Aluminum values are determined by the same design method.



# Additional Data for 2-Flange Tunnel Liner Plate



Full depth corrugation with offset end.



Full depth corrugation with standard end.



2-Flange Lap Joint

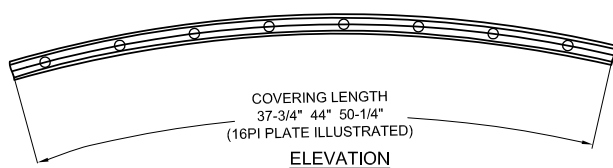
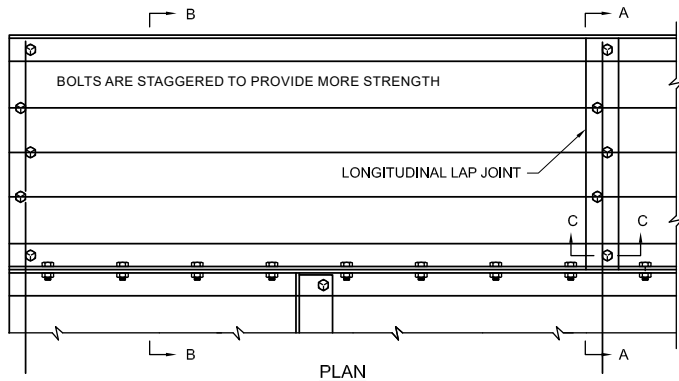
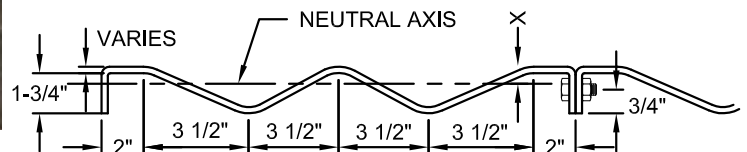

TABLE 4 - Ultimate Longitudinal Seam Strength for 2-Flange Tunnel Liner Plate (lb/LF)							
STEEL							
Specified Thickness	0.0747	0.1046	0.1345	0.1644	0.1793	0.2092	0.2391
Strength lb./ft.	20,000	30,000	47,000	55,000	62,000	87,000	92,000
ALUMINUM							
Specified Thickness	0.125	0.150	0.175	0.200	0.225	0.250	
Strength lb./ft.	35,000	45,000	50,000	60,000	70,000	74,000	

Note: In 0.0747 through 0.1793 thickness structures, longitudinal bolts are ASTM A 307, Grade A, 5/8" diameter by 1 1/4" long. For a thickness greater than 0.1793", the bolts are ASTM A449 Type 1, 5/8" diameter by 1 1/2" long.



Section A-A



Section B-B

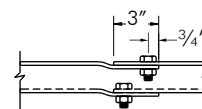

Section C-C

## Inside Dimensions

Actual reduction from neutral axis to inside value is less than the theoretical dimensions in Section B-B. To determine inside dimension, average reduction of all gages is 1 1/8" on radii or 2 1/4" on diameter.

Minimum Curving Radius = 24" (neutral axis)

# General Considerations

## Construction and Design

Tunnel loads vary widely in magnitude and classification, depending on the soils encountered and construction practices. Loads encountered during the tunneling operation are entirely different from those on the finished and grouted tunnel.

Once construction is finished and the tunnel has been grouted, a relatively uniform load distribution develops around the structure. These final loads consist of dead and live loads, if applicable.

Since loads that develop during construction depend on the tunneling procedure and soil conditions, they are difficult to predict. The installing contractor often encounters slough-ins, hydrostatic soil pressures and other forms of point loading. Handling these temporary loads, prior to backgrouting, requires proper equipment and good techniques to maintain the correct shape of the tunnel liner.

The designer should be aware that construction loads typically control the design especially in soft ground or hand-mined tunnels.

Contractors and designers utilize effectively designed liner structures with high bending resistance (stiffness) to resist concentrated loads that are common during construction.

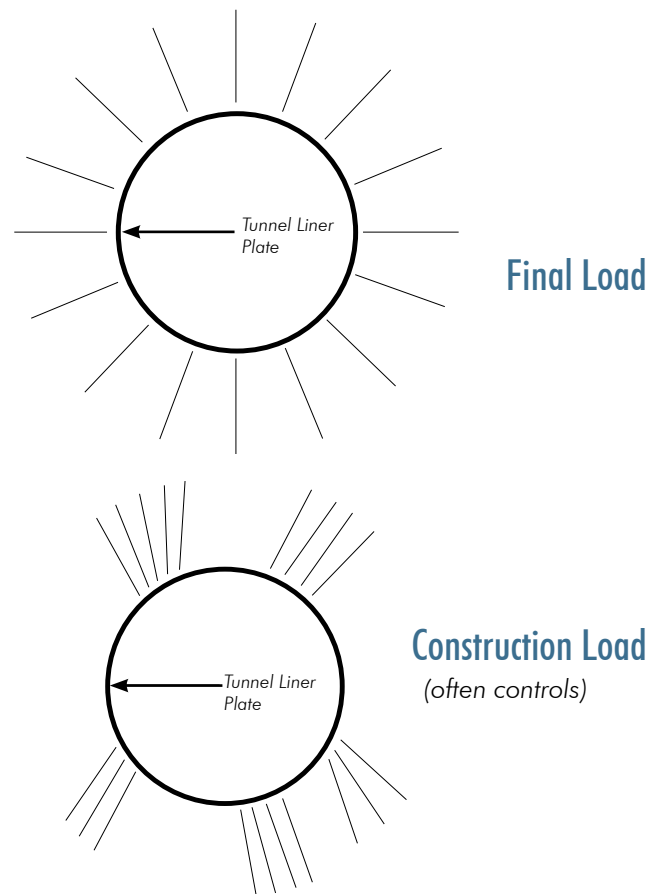

## Material and Coating Considerations

**Black Steel** » Offers both the lowest cost and high strength. Good for temporary and sacrificial requirements.

**Dip-Galvanized Steel** » Longer Service life than that of black steel.

**Dip-Galvanized & Asphalt Coated Steel** » Additional corrosion resistance & abrasion resistance.

**Aluminized Steel Type 2 (ALT2)** » Provides longer service life in certain environmental conditions that would be detrimental to a zinc/galvanic coating. Only available in 10 and 12 gages.

**Aluminum** » Provides longer service life in certain environmental conditions that would be detrimental to a zinc/galvanic coating. It is a lighter material and is easily carried into the structure. Most often considered for relines, where steel or galvanized steel has deteriorated.

# Grout Options

## Grout Coupling with Plug

For pressure grouting, liner sections may be supplied with 2" standard pipe half couplings welded into a hole in the center corrugation. Couplings are fitted with threaded plugs. These couplings are used:

- For lighter gages
- When required by specification

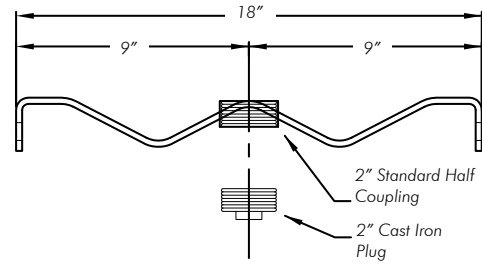

## Tapped Grout Holes

As an option, grout holes may be supplied as threaded holes on 12 GA steel and heavier plates for 2" standard pipe located in the side of the center corrugation, in the middle of the plate.

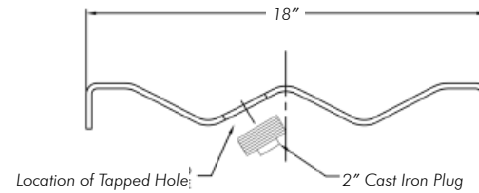

## Base Channel for Arches

Base channels are used to support arch-shaped tunnel liners.

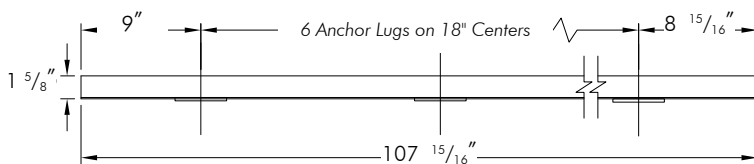

Side View

7-Gage Black or Galvanized Steel

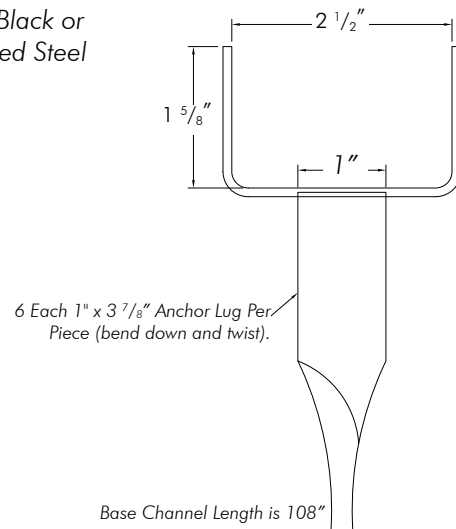

Section View

# Specification Guidelines

## Scope

This specification covers 2-Flange Tunnel Liner Plate, fabricated to permit field assembly of structure. The tunnel structure shall match the neutral axis diameter and/or shape and gage shown on the plans.

## Material

Plates shall be accurately curved to suit the tunnel cross-section and shall be of uniform fabrication to allow plates of similar curvature to be interchanged. All plates shall be punched for bolting on both the longitudinal and circumferential seams and shall be fabricated as to permit complete erection from the inside of the tunnel. Circumferential bolt hole spacing will be a multiple of the plate length to allow staggering of the longitudinal seam. Circumferential bolt spacing shall be 6 1/4" unless otherwise specified. All materials shall be fabricated in the U.S.A.

Grout holes shall be two inches (2") in diameter and shall be provided as shown on the shop drawings to permit grouting as the assembly of the Liner Plate proceeds.

**STEEL - per ASTM A1011 & A1018**

## Dip-Galvanized & Asphalt Options

Material to be galvanized shall be zinc coated in accordance with ASTM Specification A123, except that the zinc shall be applied at the rate of two ounces per square foot total for both sides or may be manufactured from galvanized steel (AASHTO M218).

## Aluminized Steel Type 2

Material to be coated in accordance with AASHTO M274. Available in 10 GA and 12 GA.

**ALUMINUM - per ASTM B746**

## Aluminum

Material to be fabricated from aluminum plates conforming to the chemical and mechanical properties of the base metal for Alloy 5052-H141 temper. Plates shall be of the gage shown on the plans and shall be curved to suit the tunnel cross section shown.

## Bolts and Nuts

Bolts and nuts shall be 5/8" in diameter and length as recommended by the manufacturer. Galvanizing shall conform to ASTM B695, Class 50.

## Design

Liner Plate shall be designed per the methodology of the AASHTO Standard Design Specification for Tunnel Liner Plates Section 15, AASHTO LRFD Section 12, or AREMA.

## Installation and Grouting

Liner Plate shall be assembled in accordance with manufacturer's recommendations. Longitudinal seams shall be staggered between rings. After rings have been installed, back grouting to fill any voids should be conducted in a manner to prevent buckling or shifting of the liner ring. The grouting crews should be scheduled as soon as practical behind the assembly operation. Staged grouting in proper lifts is important. Grouting material to be determined by the project specification.

## Excavation

Care should be taken during excavation to eliminate voids and maintain maximum plate-to-ground contact. Efficient tunneling reduces the quantity and frequency of back grouting, helps maintain tunnel shape, and proper ring compression of the Liner Plate.

In unstable soils, it is important that tunnel headings be continuously protected against any loss of ground materials. Poling plates, breast boards, shields, and soil solidification have been successful in controlling tunnel headings under unstable conditions. Use of any one of a combination of these methods may be necessary for the proper and safe advancement of the tunnel. The contractor shall be responsible for the safety of his/her employees and agents. Adequate safety measure is the contractor's responsibility and shall be given to all personnel employed by his/her firm.

## Stiffness

Wherever the soil becomes unstable, the loads on the tunnel tend to increase. Maximum ring stiffness under these conditions becomes of prime importance.

*Contech Tunnel Liner Plate is fabricated in the United States of America.*



TABLE 5

Table of Available Diameters and Dimensions, Including Number of Specific Types of Plates Required

Neutral Axis Diameter-	Approx. Inside Diameter-Inches	Approx. Outside Diameter-Inches	Approx. Outside Area-SF	Total Number Required	Plates Per Ring Plate Lengths and Offsets*									Neutral Axis Diameter-	Approx. Inside Diameter-Inches	Approx. Outside Diameter-Inches	Approx. Outside Area-SF	Total Number Required	Plates Per Ring Plate Lengths and Offsets*											
					12 Pi Plate			14 Pi Plate			16 Pi Plate								12 Pi Plate			14 Pi Plate			16 Pi Plate					
					N	S	D	N	S	D	N	S	D						N	S	D	N	S	D	N	S	D			
48	45.25	49.25	13.2	4	1	2	1									116	113.25	117.25	75.0	8					6	1		1		
50	47.25	51.25	14.3	4		2	1	1								118	115.25	119.25	77.5	8					5		1	1	1	
52	49.25	53.25	15.5	4		2		1		1						120	117.25	121.25	80.1	8					4		1	2	1	
54	51.25	55.25	16.6	4			1	1	2							122	119.25	123.25	82.9	8				1	1	1		5		
56	53.25	57.25	17.9	4				1	2	1						124	121.25	125.25	85.8	8				1		1		6		
58	55.25	59.25	19.1	4						2	1	1				126	123.25	127.25	88.5	8					1	1	1	6		
60	57.25	61.25	20.4	4							2		1		1	128	125.25	129.25	90.5	8							1	6	1	
62	59.25	63.25	21.8	4								1	1	2		130	127.25	131.25	93.9	9					7		1		1	
64	61.25	65.25	23.2	4									1	2	1	132	129.25	133.25	96.8	9					6		1	1	1	
66	63.25	67.25	24.6	5	1			1		3						134	131.25	135.25	99.8	9					5		1	2	1	
68	65.25	69.25	26.1	5				1	1	3						136	133.25	137.25	102.8	9					4		1	3	1	
70	67.25	71.25	27.7	5					1	3	1					138	135.25	139.25	105.8	9				1	1	1		6		
72	69.25	73.25	29.2	5						3	1	1				140	137.25	141.25	108.8	9				1		1		7		
74	71.25	75.25	30.8	5						3		1		1		142	139.25	143.25	111.9	9					1	1	7			
76	73.25	77.25	32.5	5					1		1		3			144	141.25	145.25	115.0	9							1	7	1	
78	75.25	79.25	34.2	5							1	1	3			146	143.25	147.25	118.1	10					7		1	1	1	
80	77.25	81.25	36.0	5								1	3	1		148	145.25	149.25	121.3	10					6		1	2	1	
82	79.25	83.25	37.8	6				1	1	4						150	147.25	151.25	124.5	10					5		1	3	1	
84	81.25	85.25	39.7	6					1	4	1					152	149.25	153.25	128.0	10					4		1	4	1	
86	83.25	87.25	41.6	6						4	1	1				154	151.25	155.25	131.5	10					1	1	1		7	
88	85.25	89.25	43.5	6						4		1		1		156	153.25	157.25	135.0	10					1		1		8	
90	87.25	91.25	45.4	6						3		1	1	1		158	155.25	159.25	138.5	10						1	1	8		
92	89.25	93.25	47.4	6					1		1		4			160	157.25	161.25	141.9	10							1	8	1	
94	91.25	95.25	49.4	6							1	1	4			162	159.25	163.25	145.5	11						7		1	2	1
96	93.25	97.25	51.5	6								1	4	1		164	161.25	165.25	149.0	11						6		1	3	1
98	95.25	99.25	53.6	7					1	5	1					166	163.25	167.25	152.6	11						5		1	4	1
100	97.25	101.25	55.8	7						5	1	1				168	165.25	169.25	156.3	11						4		1	5	1
102	99.25	103.25	58.1	7						5		1		1		170	167.25	171.25	160.0	11					1	1	1		8	
104	101.25	105.25	60.3	7						4		1	1	1		172	169.25	173.25	163.8	11					1		1		9	
106	103.25	107.25	62.6	7					1	1	1		4			174	171.25	175.25	167.6	11							1	1	9	
108	105.25	109.25	65.0	7						1		1		5		176	173.25	177.25	171.5	11								1	9	1
110	107.25	111.25	67.5	7							1	1	5			178	175.25	179.25	175.5	12						7		1	3	1
112	109.25	113.25	70.0	7								1	5	1		180	177.25	181.25	179.5	12						6		1	4	1
114	111.25	115.25	72.5	8						6	1	1				Larger diameters, in 2" increments, are available on request.														

Note: Where the tunnel clearances are important, the designer should size the structure to provide for normal deflection.

\* Type of offset at ends of plate. N = No Offset; S = Single Offset, D = Double Offset; Diameters are available above those shown in the same pattern. Structures designed for 4 Pi (12.5") stagger in longitudinal seams in alternate rings.



**Table 6**  
**2-Flange Steel Tunnel Liner Plate - Weight by Diameter**

Neutral Axis Diameter		14 GA		12 GA		10 GA		8 GA		7 GA		5 GA		3 GA	
Inches	Meters	LB/FT	KG/M	LB/FT	KG/M	LB/FT	KG/M	LB/FT	KG/M	LB/FT	KG/M	LB/FT	KG/M	LB/FT	KG/M
48	1.22	65	96	86	128	107	159	127	189	138	205	160	238	183	272
50	1.27	67	99	89	132	111	165	132	196	143	213	166	247	191	284
52	1.32	68	102	91	135	114	170	137	204	148	220	170	253	195	290
54	1.37	71	106	95	141	118	176	142	211	153	228	177	264	207	308
56	1.42	74	109	98	146	122	182	147	219	159	237	183	272	215	320
58	1.47	76	113	101	150	126	187	151	225	164	244	189	281	223	332
60	1.52	79	117	105	156	130	193	156	232	169	251	195	290	230	342
62	1.57	81	121	108	161	134	199	161	240	174	259	207	308	237	353
64	1.63	83	124	111	165	138	205	166	247	179	266	210	312	244	363
66	1.68	88	132	117	174	145	216	174	259	188	280	217	323	256	381
68	1.73	90	134	120	179	149	222	178	265	193	287	223	332	263	391
70	1.78	92	137	123	183	153	228	183	272	198	295	229	341	270	402
72	1.83	95	141	126	187	157	234	188	280	204	304	235	350	277	412
74	1.88	97	144	129	192	161	240	193	287	209	311	241	359	284	423
76	1.93	99	147	132	196	165	245	198	295	214	318	247	367	291	433
78	1.98	101	151	135	201	169	251	202	301	219	326	253	376	298	443
80	2.03	104	155	139	207	173	257	207	308	224	333	259	385	305	454
82	2.08	108	161	144	214	180	268	215	320	233	347	269	400	317	472
84	2.13	110	164	147	219	184	274	220	327	238	354	275	409	324	482
86	2.18	113	168	151	225	188	280	225	335	243	362	281	418	331	492
88	2.24	116	172	154	229	192	286	229	341	248	369	287	427	338	503
90	2.29	118	175	157	234	196	292	234	348	253	376	293	436	345	513
92	2.34	120	179	160	238	200	298	239	356	259	385	299	445	352	524
94	2.39	122	182	163	243	203	302	244	363	264	393	304	452	359	534
96	2.44	125	185	166	247	207	308	248	369	269	400	310	461	367	546
98	2.49	129	192	172	256	214	318	257	382	278	414	320	476	378	562
100	2.54	131	195	175	260	218	324	261	388	283	421	326	485	385	573
102	2.59	134	199	178	265	222	330	266	396	288	428	332	494	392	583
104	2.64	136	202	181	269	226	336	271	403	293	436	338	503	399	594
106	2.69	139	206	185	275	230	342	276	411	298	443	344	512	406	604
108	2.74	141	210	188	280	234	348	280	417	303	451	350	521	414	616
110	2.79	143	213	191	284	238	354	285	424	308	458	356	530	421	626
112	2.84	146	216	194	289	242	360	290	431	314	467	362	539	428	637
114	2.90	150	223	200	298	249	370	298	443	323	481	372	553	439	653

Notes: Approximate weights may be extrapolated for diameters greater than 180 inches.  
Weight based on dip-galvanized material and includes bolts and nuts.  
Call for aluminum tunnel liner plate weights.



**Table 6 (continued)**  
**2-Flange Steel Tunnel Liner Plate - Weight by Diameter**

Neutral Axis Diameter		14 GA		12 GA		10 GA		8 GA		7 GA		5 GA		3 GA	
Inches	Meters	LB/FT	KG/M	LB/FT	KG/M	LB/FT	KG/M	LB/FT	KG/M	LB/FT	KG/M	LB/FT	KG/M	LB/FT	KG/M
116	2.95	152	227	203	302	253	376	303	451	328	488	378	562	446	664
118	3.00	155	230	206	306	257	382	308	458	333	495	384	571	453	674
120	3.05	157	233	209	311	261	388	312	464	338	503	390	580	460	684
122	3.10	159	237	212	315	265	394	317	472	343	510	396	589	486	696
124	3.15	161	240	215	320	269	400	322	479	348	518	402	598	475	707
126	3.20	164	244	219	326	273	406	327	487	353	525	408	607	482	717
128	3.25	167	248	222	330	276	411	331	492	359	534	414	616	489	728
130	3.30	170	253	227	338	283	421	339	504	367	546	424	631	500	744
132	3.35	173	258	231	344	287	427	344	512	372	553	430	640	507	754
134	3.40	176	261	234	348	291	433	349	519	378	562	436	649	514	765
136	3.45	178	264	237	353	295	439	354	529	383	570	442	658	522	777
138	3.51	180	268	240	358	299	445	358	533	388	577	448	667	529	787
140	3.56	182	271	243	362	303	451	363	540	393	585	454	675	536	797
142	3.61	185	275	246	366	307	457	368	548	398	592	460	684	543	808
144	3.66	187	278	249	370	311	463	373	555	403	600	466	693	550	818
146	3.71	191	285	255	379	318	473	381	567	412	613	476	708	561	835
148	3.76	194	288	258	384	322	479	386	574	417	620	482	717	569	847
150	3.81	196	291	261	388	326	485	390	580	422	628	488	726	576	857
152	3.86	199	296	265	394	330	491	395	588	428	637	494	735	583	867
154	3.91	201	299	268	399	334	497	400	595	433	644	499	742	590	878
156	3.96	203	302	271	403	338	503	405	603	438	652	505	751	597	888
158	4.01	206	306	274	408	342	509	409	609	443	659	511	760	604	899
160	4.06	208	309	277	412	346	515	414	616	448	667	517	769	611	909
162	4.11	212	316	283	421	353	525	422	628	457	680	527	784	623	927
164	4.17	215	319	286	426	356	530	427	635	462	687	533	793	630	937
166	4.22	217	322	289	430	360	534	432	643	467	695	539	802	637	948
168	4.27	219	326	292	434	364	542	436	649	472	702	545	811	644	958
170	4.32	221	329	295	439	368	548	441	656	478	711	551	820	651	969
172	4.37	224	334	299	445	372	553	446	664	483	719	557	829	658	979
174	4.42	227	337	302	449	376	559	451	671	488	726	563	838	665	989
176	4.47	229	340	305	454	380	565	456	678	493	733	569	847	672	1000
178	4.52	233	347	311	463	387	576	464	690	502	747	579	861	684	1018
180	4.57	236	350	314	467	391	582	468	696	507	754	585	870	691	1028

Notes: Approximate weights may be extrapolated for diameters greater than 180 inches.  
 Weight based on dip-galvanized material and includes bolts and nuts.  
 Call for aluminum tunnel liner plate weights.

# Steel Vertical Shafts

Vertical Shafts are often required as access means for horizontal tunneling and relines. These shafts may vary in diameter from 4 feet to over 70 and depths well over 100 feet.



2-Flange Tunnel Liner Plate is the stiffest plate available and, unlike other shaft liner systems, often does not require the use of permanent ring-beam stiffeners.

The Contech Liner Plate system, available in black (uncoated) or galvanized steel, provides strength and safety. Often, the Liner Plate may be dismantled and reused.

2-Flange Tunnel Liner Plate is much stiffer, gage for gage, than 4-Flange Liner Plate. Commonly required diameters for 2-Flange Liner Plate will not require Ring-Beam bracing, whereas 4-Flange designs would more than likely require them.

If adjacent structures are sensitive to pile driving, a starter shaft using 2-Flange Tunnel Liner Plate can be used. Once the shaft reaches sufficient depth, pile driving can be commenced and disturbance to nearby foundations, railroads or other structures is minimized or eliminated.

## Optimizing Shaft Design

In each case, maintaining shaft integrity requires a dependable support system. Various methods are used for vertical shaft lining: sheet piling, unbraced timber, ring beams and timber lagging, concrete, and stacked trench boxes.

## Liner Plate Systems

2-Flange Tunnel Liner Plate is used in vertical shafts when the top-down installation is preferred. A net laying depth of 18" permits advancing the shaft in 1.5' increments. Bolts and nuts for 2-Flange Tunnel Liner Plate are easily installed from within the structure and rings of Liner Plate can be quickly installed and backgrouted.

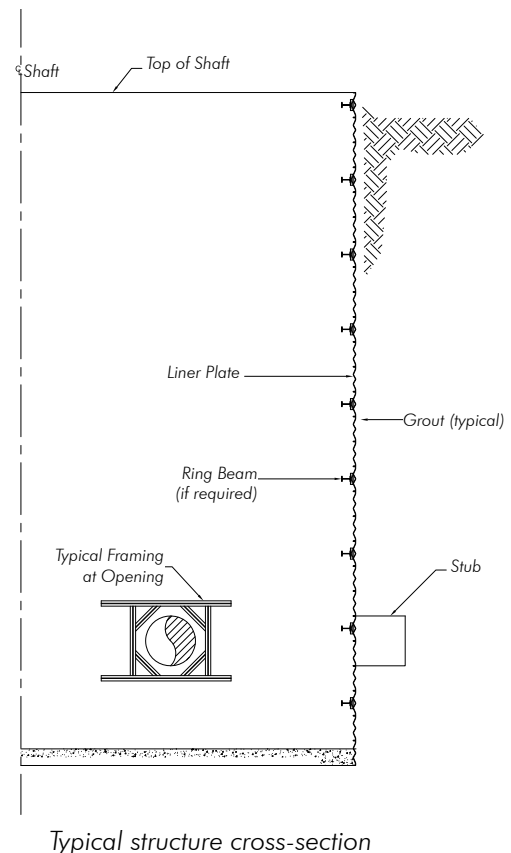



# Additional Contech Products Provide Versatility for Optimum Efficiency

## MULTI-PLATE Liner Systems

MULTI-PLATE® can be preassembled on the surface in large diameters and long lengths, then lowered into a pre-excavated or drilled shaft. Once installed, the void between the MULTI-PLATE liner and excavated/drilled shaft is grouted. Soil conditions must allow the shaft walls to be left temporarily exposed until the liner is installed.

MULTI-PLATE shaft liners are also extremely stiff, creating a very safe shaft and, as with 2-Flange Tunnel Liner Plate, ring beam stiffeners are often not required.

## HEL-COR Lining Systems

HEL-COR® corrugated steel pipe, with or without ring beam stiffeners, can be supplied in diameters up to 120" (larger diameters are available at some locations). It is installed in the same manner as MULTI-PLATE structures, and eliminates the need for field assembly of plates. Ring beams, if needed, are installed by the contractor.

## Applications

These additional products offer alternative options for different site or construction conditions. Site restrictions will often not allow drilling shafts. When "hand-digging" or bucket excavation is required, 2-Flange Tunnel Liner Plate is the most effective. If drilling of the shaft is allowed and the site soil will remain stable, then larger diameter shafts can be lined with MULTI-PLATE or HEL-COR corrugated steel pipe.

2-Flange Tunnel Liner Plate and MULTI-PLATE structures can be supplied in round or elliptical shapes. Smaller shaft diameters can be lined with HEL-COR alone or with ring beam stiffeners if required.

Prompt backgrouting, to fill the void between the shaft walls and the liner, is essential to the support and performance of any shaft liner system. Such backgrouting must be done in a controlled and balanced manner. In all cases, use of temporary bracing may be required to provide added protection and stiffness prior to backgrouting.



MULTI-PLATE®



HEL-COR®

# Design Considerations for Vertical Shafts

## Typical Required Design Information

- Shaft diameter
- Shaft depth
- Unit weight of soil around the shaft
- Lateral earth pressures due to site soil conditions
- Location of ground water table
- Live loads to include in the design

While the actual design of such shafts is the responsibility of the project engineer, a common procedure for this design process can be summarized as:

### 1. Determine Loads on Shaft Liner

Loads exerted by lateral earth pressures should be determined throughout the depth of the shaft. Any hydrostatic loads due to groundwater should be established and included within the design. The possibility for localized soil instabilities and slough-ins should be assessed and considered. If such localized loads produce differential pressures, then allowances for such unbalanced loads must be considered in the design and detail of the shaft. If the presence of any nearby foundation systems will produce an increase in the ground pressures in the area where the shaft is to be constructed that exceed 100 pounds per square foot, they should be included in the design.

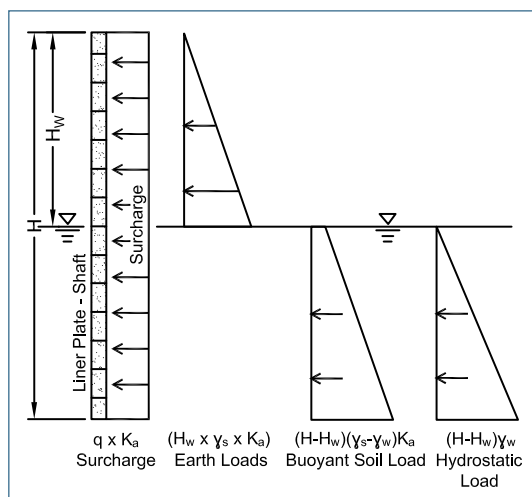

Loads on Shaft Liner



### 2. Check the Seam Strength of the Liner

The design thrust in the plate should be computed in the same manner as was shown for tunneling applications. In tunneling applications, a minimum factor of safety of 3.0 on seam strength is common and is required per the AASHTO specifications. However, this does not necessarily apply and may in fact be overly conservative in the design of vertical shafts. The selection of an appropriate factor of safety is left to the discretion of the designer.

### 3. Check the Liner Stiffness

Due to the inherent stiffness and the moment transfer that the lapped longitudinal seams of 2-Flange Tunnel Liner Plate provide, a large range of depth and diameter combinations of vertical shafts can be constructed without the need for any additional reinforcement. However, while the rings of some larger shafts may be capable of carrying the service loads required by the permanent structure, the shaft may require temporary reinforcement during construction to provide additional stiffness during the assembly and grouting phases of construction. This reinforcement is commonly in the form of curved ring beams that can be temporarily blocked into place during construction, but removed once the shaft is assembled and grouted into place.

If the gage of the structure is controlled by the need for ring stiffness rather than load carrying capacity, many designers choose to design the required plate gage based strictly on what is required to carry the service loads and specify the use of ring beams to provide the necessary stiffness during construction. Generally two or three sets of ring beams is all that is necessary for construction as the ring beams can be moved downward as the shaft construction progresses. This can lead to a substantial reduction in the cost of materials for a large diameter and/or deep tunnel.

#### 4. Check the Critical Buckling Stress of the Shaft Liner

This check can be performed using the same buckling equations introduced earlier for Liner Plate tunnels. Due to the strength of 2-Flange Tunnel Liner Plate, many large diameter and deep shafts can be constructed without the need for permanent reinforcement. If the service loads induce stresses beyond the limits that 2-Flange Tunnel Liner Plate alone can carry, permanent reinforcement in the form of ring beams or other means can be used to carry the loads beyond what the plates can accommodate. The addition of these ring stiffeners should be considered in the buckling check and modifications to the buckling check procedure may be required.

#### 5. Design Reinforcing for Any Openings Cut in the Shaft Liner Wall

Any openings that may be cut within the Liner Plate may also require permanent reinforcement. In this instance, structural members are generally attached to the Liner Plate around the cut opening in the form of a frame to carry the loads in the vicinity of the opening.

#### 6. Grouting the Void Between the Liner Plate and the Shaft Walls

The void between the shaft liner and excavated shaft wall should be grouted in a controlled and balanced manner as soon as possible as the shaft liner construction is advanced. The quicker this void is grouted and the grout cured, the less exposed the shaft liner will be to localized slough-ins, potential unbalanced loads, and unknown load pressures. Selection of grout materials and methods should be discussed and coordinated with the contractor.

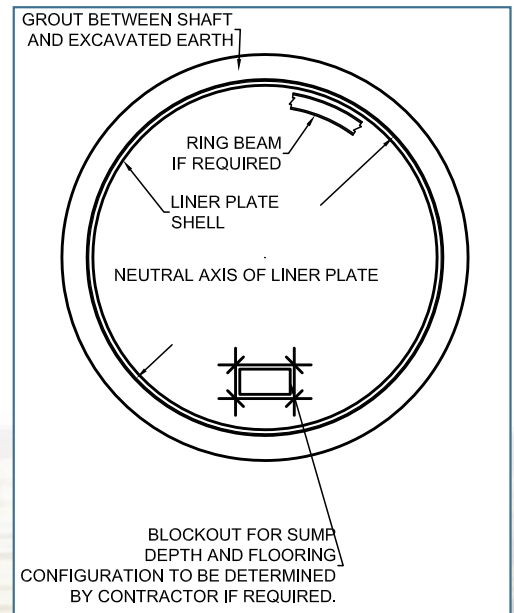

*Note: Additional references include the current specifications of AASHTO, AISI, and the NCSPA.*





Contech Engineered Solutions provides site solutions for the civil engineering industry. Contech's portfolio includes bridges, drainage, retaining walls, sanitary sewer, stormwater, erosion control and soil stabilization products.

**For more information, call one of Contech's Regional Offices located in the following cities:**

**Ing. Félix González Leal**

**Cel. 8181618822 y 8118071834**

**email: felix.gonzalez.leal@gmail.com**

[www.firheg.com](http://www.firheg.com)

NOTHING IN THIS CATALOG SHOULD BE CONSTRUED AS A WARRANTY. APPLICATIONS SUGGESTED HEREIN ARE DESCRIBED ONLY TO HELP READERS MAKE THEIR OWN EVALUATIONS AND DECISIONS, AND ARE NEITHER GUARANTEES NOR WARRANTIES OF SUITABILITY FOR ANY APPLICATION. CONTECH MAKES NO WARRANTY WHATSOEVER, EXPRESS OR IMPLIED, RELATED TO THE APPLICATIONS, MATERIALS, COATINGS, OR PRODUCTS DISCUSSED HEREIN. ALL IMPLIED WARRANTIES OF MERCHANTABILITY AND ALL IMPLIED WARRANTIES OF FITNESS FOR ANY PARTICULAR PURPOSE ARE DISCLAIMED BY CONTECH. SEE CONTECH'S CONDITIONS OF SALE (AVAILABLE AT [WWW.CONTECHES.COM/COS](http://WWW.CONTECHES.COM/COS)) FOR MORE INFORMATION.